

Pendant Light Fitting IEC

Series 6470



www.stahl.de



11435E00

- > Available light sources
 - high-pressure sodium lamps (HSE)
 - metal halide lamps (HIE)
 - mercury lamps (HME)
 - blended lamps (LME)
 - halogen lamps (QT)
- > Versatile mounting methods
- > Enclosure made of saltwater-resistant aluminium

E2



| | ATEX / IECEx / GOST | | | | | |
|------------|---------------------|---|---|----|----|----|
| Zone | 0 | 1 | 2 | 20 | 21 | 22 |
| For use in | | | x | | x | x |

WebCode 6470A

Pendant Light Fitting IEC

Series 6470

Selection table

| Version | Lamps ¹⁾ | Lamp holder | Lamp wattage | Temperature class at Ta = | | T _{S max} at Ta = 55 °C | Order number | Weight kg |
|--|---------------------|-------------|--------------|---------------------------|-------|-------------------------------------|------------------------|--------------|
| | | | | 40 °C | 55 °C | | | |
| Pendant light fitting IEC Series 6470 size 1 up to 150 W | QT | E27 | 150 W | T4 | T4 | 121 °C | 6470/11...-1151-0...-1 | 5.900 |
| | | | 250 W | T4 | T3 | 149 °C | 6470/11...-1251-0...-1 | 5.300 |
| | LME | E27 | 160 W | T4 | T3 | 143 °C | 6470/11...-1161-0...-1 | 5.217 |
| | HIE | E27 | 70 W | T5 | T4 | 103 °C | 6470/11...-2071-...-1 | 6.797 |
| | | | 100 W | T4 | T4 | 121 °C | 6470/11...-2101-...-1 | 7.197 |
| | | | 150 W | T4 | T3 | 140 °C | 6470/11...-2151-...-1 | 8.115 |
| | HSE | E27 | 50 W | T5 | T5 | 98 °C | 6470/11...-3051-...-1 | 6.297 |
| | | | 70 W | T4 | T4 | 106 °C | 6470/11...-3071-...-1 | 6.797 |
| | HME | E27 | 125 W | T4 | T3 | 142 °C | 6470/11...-4121-...-1 | 6.463 |

* at maximum ambient temperature of 40 °C

Order Number Supplement

| | | | |
|---------------|--|---------------------|-------|
| Installation | Pendant mounting by means of ring bolts | 6470/1.1-..... | 1.164 |
| | Ceiling mounting | 6470/1.3-..... | 1.064 |
| | Wall mounting | 6470/1.4-..... | 1.937 |
| | Pole mounting 25° | 6470/1.5-..... | 1.144 |
| Cable entries | 4 x M25 x 1.5 (Standard) → 1 x cable entries, 3 x stopping plugs | 6470/1..1-..... | 0.035 |
| | 4 x M20 x 1.5 → 1 x cable entries, 3 x stopping plugs | 6470/1..2-..... | 0.024 |
| | 4 x M25 x 1.5 for through wiring → 2 x cable entries, 2 x stopping plugs | 6470/1..3-..... | 0.045 |
| | 4 x M20 x 1.5 for through wiring → 2 x cable entries, 2 x stopping plugs | 6470/1..4-..... | 0.031 |
| | 1 1/2" BSP for pole mounting | 6470/1..5-..... | |
| | 1 1/4" BSP for pole mounting | 6470/1..6-..... | |
| Compensation | without compensation | 6470/11...-0...- | |
| | with compensation | 6470/11...-1...- | 0.064 |
| Wire guard | without wire guard | 6470/11...-0..- | |
| | with wire guard | 6470/11...-1..- | 0.240 |
| Surface | with colour (standard) | 6470/1...-.....0..- | |

Notes:

| | |
|------------------|------------------------------|
| ¹⁾ QT | → Halogen lamp |
| LME | → Blended lamps |
| HIE | → Metal halide lamps |
| HSE | → High-pressure sodium lamps |
| HME | → Mercury lamps |

- The light fittings are supplied without lamps.
- The light fittings are compensated.

Pendant Light Fitting IEC

Series 6470



Selection table

| Version | Lamps ¹⁾ | Lamp holder | Lamp wattage | Temperature class at Ta = | | T _{S,max} at Ta = | Order number | Weight kg |
|--|---------------------|-------------|--------------|---------------------------|-------|----------------------------|------------------------|--------------|
| | | | | 40 °C | 55 °C | | | |
| Pendant light fitting IEC Series 6470 size 2 up to 250 W | LME | E40 | 250 W | T3 | T3 | 170 °C | 6470/12...-1252-0...-1 | 6.091 |
| | HIE | E40 | 250 W | T3 | -- | 145 °C * | 6470/12...-2252-...-1 | 9.596 |
| | HSE | E40 | 100 W | T5 | T4 | 112 °C | 6470/12...-3102-...-1 | 10.000 |
| | | | 150 W | T4 | T4 | 130 °C | 6470/12...-3152-...-1 | 9.260 |
| | | | 250 W | T3 | -- | 157 °C | 6470/12...-3252-...-1 | 9.596 |
| | HME | E40 | 250 W | T3 | -- | 172 °C * | 6470/12...-4252-...-1 | 8.139 |

* at maximum ambient temperature of 40 °C

Order Number Supplement

| | | | |
|---------------|--|---------------------------|-------|
| Installation | Pendant mounting by means of ring bolts | 6470/1.1-...-...-...-... | 1.164 |
| | Ceiling mounting | 6470/1.3-...-...-...-... | 1.064 |
| | Wall mounting | 6470/1.4-...-...-...-... | 1.937 |
| | Pole mounting 25° | 6470/1.5-...-...-...-... | 1.144 |
| Cable entries | 4 x M25 x 1.5 (Standard) → 1 x cable entries, 3 x stopping plugs | 6470/1..1-...-...-...-... | 0.035 |
| | 4 x M20 x 1.5 → 1 x cable entries, 3 x stopping plugs | 6470/1..2-...-...-...-... | 0.024 |
| | 4 x M25 x 1.5 for through wiring → 2 x cable entries, 2 x stopping plugs | 6470/1..3-...-...-...-... | 0.045 |
| | 4 x M20 x 1.5 for through wiring → 2 x cable entries, 2 x stopping plugs | 6470/1..4-...-...-...-... | 0.031 |
| | 1 1/2" BSP for pole mounting | 6470/1..5-...-...-...-... | |
| | 1 1/4" BSP for pole mounting | 6470/1..6-...-...-...-... | |
| Compensation | without compensation | 6470/12...-...-...-0...- | |
| | with compensation | 6470/12...-...-...-1...- | 0.064 |
| Wire guard | without wire guard | 6470/12...-...-...-0...- | |
| | with wire guard | 6470/12...-...-...-1...- | 0.280 |
| Surface | with colour (standard) | 6470/1...-...-...-0...- | |

Notes: ¹⁾ LME → Blended lamps
HIE → Metal halide lamps
HSE → High-pressure sodium lamps
HME → Mercury lamps

- The light fittings are supplied without lamps.
- The light fittings are compensated.

E2

Pendant Light Fitting IEC

Series 6470

Selection table

| Version | Lamps ¹⁾ | Lamp holder | Lamp wattage | Temperature class at Ta = | | T _S max at Ta = 55 °C | Order number | Weight kg | | |
|--|---------------------|-------------|--------------|---------------------------|-------|-------------------------------------|------------------------|--------------|-----------------------|--------|
| | | | | 40 °C | 55 °C | | | | | |
| Pendant light fitting IEC Series 6470 size 3 up to 600 W | QT LME | E40 | 500 W | T4 | T3 | 142 °C | 6470/13...-1502-0...-1 | 10.868 | | |
| | | | | T3 | T3 | 165 °C | | | | |
| | HIE | E40 | 250 W | T4 | T4 | 130 °C | 6470/13...-2252-...-1 | 14.834 | | |
| | | | 400 W | T3 | T3 | 155 °C | | | 6470/13...-2402-...-1 | 15.545 |
| | HSE | E40 | 250 W | T4 | T4 | 132 °C | 6470/13...-3252-...-1 | 14.834 | | |
| | | | 400 W | T4 | T3 | 146 °C | | | 6470/13...-3402-...-1 | 15.545 |
| | | | 600 W | T3 | -- | 166 °C * | | | | |
| | HME | E40 | 250 W | T4 | T3 | 145 °C | 6470/13...-4252-...-1 | 13.377 | | |
| | | | 400 W | T3 | -- | 153 °C * | | | 6470/13...-4402-...-1 | 13.708 |

* at maximum ambient temperature of 40 °C

Order Number Supplement

| | | | |
|---|--|---------------------------|--------|
| Installation | Ceiling mounting | 6470/133-...-...-...-... | 1.600 |
| Cable entries | 4 x M25 x 1.5 (Standard) → 1 x cable entries, 3 x stopping plugs | 6470/13.1-...-...-...-... | 0.034 |
| | 4 x M20 x 1.5 → 1 x cable entries, 3 x stopping plugs | 6470/13.2-...-...-...-... | 0.024 |
| | 4 x M25 x 1.5 for through wiring → 2 x cable entries, 2 x stopping plugs | 6470/13.3-...-...-...-... | 0.044 |
| | 4 x M20 x 1.5 for through wiring → 2 x cable entries, 2 x stopping plugs | 6470/13.4-...-...-...-... | 0.032 |
| Compensation | without compensation | 6470/13...-...-...-0...- | 10.650 |
| | with compensation | 6470/13...-...-...-1...- | 10.650 |
| Wire guard | without wire guard | 6470/13...-...-...-0...- | 10.650 |
| | with wire guard | 6470/13...-...-...-1...- | 0.280 |
| Surface | with colour (standard) | 6470/13...-...-...-0...- | 10.650 |
| Notes: 1) QT → Halogen lamp LME → Blended lamps HIE → Metal halide lamps HSE → High-pressure sodium lamps HME → Mercury lamps | | | |
| <ul style="list-style-type: none"> - The light fittings are supplied without lamps. - The light fittings are compensated. | | | |

Explosion protection

| | |
|-----------------------------------|--|
| Global (IECEx) | |
| Gas and dust | IECEx PTB 06.0007 Ex nR IIC T* Gc Ex tb IIIC IP66 T* °C Db * temperature classes and surface temperatures see selection table |
| Europe (ATEX) | |
| Gas and dust | PTB 05 ATEX 2045 (Zones 2, 22) PTB 05 ATEX 2043 (Zone 21) ⊕ II 3 G Ex nR IIC T* Gc ⊕ II 2 D Ex tb IIIC IP66 T* °C Db ⊕ II 3 D Ex tc IIIC IP66 T* °C Dc * temperature classes and surface temperatures see selection table |
| Certificates and approvals | |
| Certificates | IECEx, ATEX, Russia (GOST-R), Kazakhstan (GOST-K), Belarus (GOST-B), Ukraine (GOST-U), Taiwan (ITRI) |
| Other certificates | Ship Approval (GL) |

Pendant Light Fitting IEC

Series 6470



Technical data

Electrical data

| | | | | |
|---------------------------------|---|-------|--|--|
| Rated operational voltage U_e | 230 V ($\pm 6\%$), AC, 50 Hz, others on request | | | |
| Rated current | Note information on the type label | | | |
| | Lamps | Power | Lamp holder | I_N |
| | Halogen lamp | QT | 150 W 205 W 500 W | E27 E27 E40 |
| | Blended lamps | LME | 160 W 250 W 500 W | E27 E40 E40 |
| | Metal halide lamps | HIE | 70 W 100 W 150 W 250 W 400 W | E27 E27 E27 E40 E40 |
| | High-pressure Esodium lamps | HSE | 50 W 70 W 100 W 110 W 150 W 250 W 400 W 600 W | E27 E27 E40 E27 E40 E40 E40 E40 |
| | Mercury lamps | HME | 125 W 250 W 400 W | E27 E40 E40 |
| Power factor | $\cos \varphi \geq 0.9$ (compensated) | | | |

Ambient conditions

| | | | |
|---------------------|---------|--|---|
| Ambient temperature | 6470/11 | -20 ... +40 °C -30 ... +55 °C -50 ... +55 °C | all versions HSE, HIE QT, LME, HME |
| | 6470/12 | -20 ... +40 °C -30 ... +55 °C -30 ... +40 °C -50 ... +55 °C -50 ... +40 °C | all versions HSE 100W, 150W HSE 250W, HIE 250W LME 250W HME 250W |
| | 6470/13 | -20 ... +40 °C -30 ... +55 °C -30 ... +40 °C -50 ... +55 °C -50 ... +40 °C | all versions HSE 250W, 400W, HIE 250W, 400W HSE 600W QT 500W, LME 500W, HME 250W HME 400W |

Mechanical data

| | |
|----------------------|---|
| Degree of protection | IP66 |
| Protection class | I (PE-connection) |
| Material | |
| Enclosure material | saltwater-resistant aluminium |
| Glass cover | thermal shock resistant borosilicate glass |
| Cover seal | silicone rubber |
| Glass seal | silicone rubber |
| Mounting bracket | Stainless steel |
| External reflector | powder coated galvanised sheet steel / glass fibre reinforced polyester |
| Wire guard | saltwater-resistant aluminium |
| Enclosure lock | Mounting screw M8 (stainless steel) |

Mounting / installation







| | |
|-----------------------------------|--|
| Operating position | pendant mounting or slewing angle (30° and 45°) |
| Mounting | wall and ceiling, pole, pendant by means of ring bolts or mounting brackets |
| Cable glands | Certified cable entries with an ingress Protection of IP66 minimum must be used (in acc. with 94/9/EC). The number of cable entries depends on the type of mounting. |
| | Standard M25 x 1.5 |
| | Special entry M20 x 1.5, others on request |
| Connection option | L1 + N for 4 mm ² flexible and 6 mm ² solid via internal terminal block |
| Screw-in thread for pole mounting | 1 1/4" BSP, 1 1/2" BSP |
| Wire guard and external reflector | can easily be mounted later using a mounting screw M6 |

E2

Pendant Light Fitting IEC

Series 6470

Accessories and spare parts

| Designation | Illustration | Description | | | | Art. no. | Weight kg |
|---|---|-------------|-------------|---------|---------------|---------------|--------------|
| | | Power | Lamp holder | Voltage | Light current | | |
| Halogen lamps QT |  05355E00 | 205 W | E27 | 230 V | 4200 lm | 203469 | 0.100 |
| | | 150 W | E27 | 230 V | 2870 lm | 207458 | 0.080 |
| | | 500 W | E40 | 230 V | 10250 lm | 108874 | 0.132 |
| Blended lamps LME |  04963E00 | 160 W | E27 | 230 V | 3200 lm | 108899 | 0.082 |
| | | 250 W | E40 | 230 V | 5400 lm | 108361 | 0.220 |
| | | 500 W | E40 | 230 V | 13000 lm | 108362 | 0.300 |
| Metal halide lamps HIE |  04963E00 | 70 W | E27 | 230 V | 5100 lm | 109307 | 0.100 |
| | | 100 W | E27 | 230 V | 7700 lm | 109308 | 0.420 |
| | | 150 W | E27 | 230 V | 11500 lm | 109309 | 0.110 |
| | | 250 W | E40 | 230 V | 20000 lm | 108883 | 0.195 |
| | | 400 W | E40 | 230 V | 34000 lm | 108885 | 0.284 |
| High-pressure sodium lamps HSE |  04963E00 | 50 W | E27 | 230 V | 3500 lm | 109350 | 0.075 |
| | | 70 W | E27 | 230 V | 5600 lm | 109105 | 0.074 |
| | | 100 W | E40 | 230 V | 9500 lm | 109504 | 0.081 |
| | | 150 W | E40 | 230 V | 14500 lm | 108900 | 0.285 |
| | | 250 W | E40 | 230 V | 27000 lm | 108901 | 0.200 |
| | | 400 W | E40 | 230 V | 48000 lm | 108903 | 0.340 |
| |  05355E00 | 600 W | E40 | 230 V | 90000 lm | 109310 | 0.220 |
| High-pressure sodium lamps HSE (TwinArc) |  04963E00 | 50 W | E27 | 230 V | 4000 lm | 109493 | 0.070 |
| | | 70 W | E27 | 230 V | 6500 lm | 109494 | 0.070 |
| | | 100 W | E40 | 230 V | 9500 lm | 109495 | 0.100 |
| | | 150 W | E40 | 230 V | 17000 lm | 109496 | 0.200 |
| | | 250 W | E40 | 230 V | 32000 lm | 109497 | 0.250 |
| | | 400 W | E40 | 230 V | 55000 lm | 109498 | 0.290 |
| Mercury lamps HME |  04963E00 | 125 W | E27 | 230 V | 6200 lm | 111685 | 0.080 |
| | | 250 W | E40 | 230 V | 12700 lm | 111686 | 0.210 |
| | | 400 W | E40 | 230 V | 22000 lm | 111687 | 0.400 |





Pendant Light Fitting IEC

Series 6470



E2



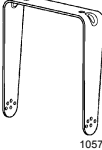
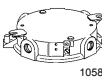
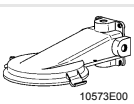



Accessories and spare parts

| Designation | Illustration | Description | Art. no. | Weight kg | |
|-------------------------------|---|---|--------------------------------|---------------|-------|
| Safety glass |  10572E00 | temperature resistant borosilicate glass with screw-in thread | | | |
| | | for 6470/11 | 123041 | 3.370 | |
| | | for 6470/12 | 123051 | 4.400 | |
| | | for 6470/13 | 123052 | 6.600 | |
| Wire guard |  10571E00 | made of saltwater-resistant aluminium, with mounting parts | | | |
| | | for 6470/11 | 123038 | 0.250 | |
| | | for 6470/12 | 123039 | 0.300 | |
| | | for 6470/13 | 123040 | 0.600 | |
| Standard reflector |  10288E00 | made of powder coated galvanised sheet steel, with mounting parts | | | |
| | | for 6470/11 and 6470/12 | 123042 | 2.250 | |
| | | made of glass fibre reinforced polyester, with mounting parts | | | |
| | | for 6470/13 | 123053 | 5.500 | |
| Reflector 30° |  06249E00 | made of glass fibre reinforced polyester, with mounting parts | | | |
| | | for 6470/11 and 6470/12 | 123043 | 0.600 | |
| Mounting bracket |  10570E00 | made of stainless steel, with mounting parts | | 0.000 | |
| | | for 6470/11 and 6470/12 | 122757 | 1.200 | |
| | | for 6470/13 | 122758 | 1.500 | |
| Cover for ceiling mounting |  10580E00 | Ceiling mounting via taps located on the cover. A mounting bracket or ring bolts can be attached to the cover later (must be ordered as accessory). | | 0.000 | |
| | | with thread M20 x 1.5 | for 6470/11 and for 6470/12 | 122750 | 1.264 |
| | | with thread M20 x 1.5 | for 6470/13 | 122754 | 1.850 |
| | | with thread M25 x 1.5 | for 6470/11 and for 6470/12 | 122749 | 1.264 |
| | | with thread M25 x 1.5 | for 6470/13 | 122753 | 1.850 |
| Cover for wall mounting |  10573E00 | with thread M20 x 1.5 | for 6470/11 and for 6470/12 | 123009 | 2.137 |
| | | with thread M20 x 1.5 | for 6470/13 | 123027 | 3.600 |
| | | with thread M25 x 1.5 | for 6470/11 and for 6470/12 | 123008 | 2.137 |
| | | with thread M25 x 1.5 | for 6470/13 | 123026 | 3.600 |

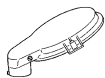
Pendant Light Fitting IEC

Series 6470

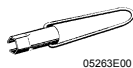
Accessories and spare parts

| Designation | Illustration | Description | Art. no. | Weight kg | |
|---|---|--|---------------|---------------|-------|
| Cover for pole mounting 25° |  10577E00 | with thread 1 1/2" BSP for 6470/11 and for 6470/12 | 123016 | 1.113 | |
| | | with thread 1 1/2" BSP for 6470/13 | 123034 | 2.300 | |
| | | with thread 1 1/4" BSP for 6470/11 and for 6470/12 | 123017 | 1.113 | |
| | | with thread 1 1/4" BSP for 6470/13 | 123035 | 2.300 | |
| Ring bolts |  05378E00 | M8, direct mounting in insert nuts, 1 pair | 115736 | 0.120 | |
| | | M10, direct mounting in insert nuts, 1 pair | 118560 | 0.208 | |
| Cable entries |  05864E00 | of moulded material, series 8161 | | | |
| | | 8161/5-M20-13 | 1 piece | 138518 | 0.012 |
| | | 8161/5-M20-13 | 50 pieces | 138454 | 0.600 |
| | | 8161/5-M25-17 | 1 piece | 138520 | 0.020 |
| Stopping plug |  04840E00 | of moulded material, series 8290 | | | |
| | | 8290/3-M20 | 1 piece | 143522 | 0.005 |
| | | 8290/3-M20 | 100 pieces | 143543 | 0.500 |
| | | 8290/3-M25 x 1,5 | 1 pieces | 143524 | 0.007 |
| Special key |  05263E00 | for tightening cable glands respectively cap nuts for cable glands | | | |
| | | thread size packing unit | | | |
| Handheld testing instrument for gastight enclosures |  11006E00 | M20 x 1.5 1 | 114208 | 0.132 | |
| | | For testing of restricted breathing of gastight enclosures of type Ex nR | 161825 | 0.730 | |

Pendant Light Fitting IEC

Series 6470



Dimensional Drawings (All Dimensions in mm) - Subject to Alterations

| Dim. in mm | 6470/11 | 6470/12 | 6470/13 |
|------------|---------|---------|---------|
| A | 277 | 277 | 372 |
| B | 352 | 414 | 514 |
| C | 230 | 230 | 310 |
| D | 353 | 353 | 521 |
| E | 240 | 240 | 329 |
| F | 357 | 423 | 533 |
| G | 180 | 180 | 260 |
| H | M8 | M8 | M10 |
| I | 358 | 424 | 535 |
| J | 444 | 444 | 715 |

Ceiling mounting without wire guard (10574E00)

Ceiling mounting with wire guard (10566E00)

Ceiling mounting with reflector (10564E00)

| Dim. in mm | 6470/11 | 6470/12 | 6470/13 |
|------------|---------|---------|---------|
| A | 277 | 277 | 372 |
| B | 352 | 414 | 514 |
| C | 230 | 230 | 310 |
| G | 180 | 180 | 260 |
| H | M 8 | M 8 | M 10 |
| K | 20 | 20 | 25 |
| L | 18 | 18 | 22.5 |

Pendant mounting by means of ring bolts (10568E00)

E2

Pendant Light Fitting IEC

Series 6470

Dimensional Drawings (All Dimensions in mm) - Subject to Alterations

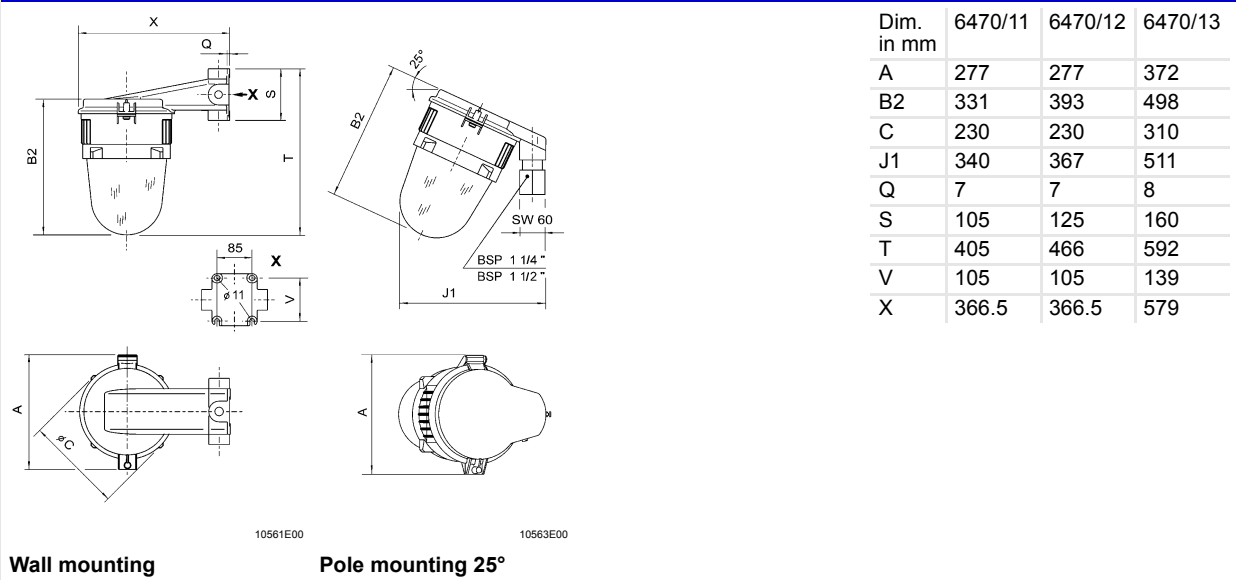

We reserve the right to make alterations to the technical data, dimensions, weights, designs and products available without notice. The illustrations cannot be considered binding.